

Print Options Australia 2008



Animal
Management
Systems

Dalton[®]

Supertag Maxi (Size 5) TD5M or TD5F



TPRT1
Print Option 1



TPRT2
Print Option 2



TPRT3
Print Option 3

Supertag Maxi (Size 5) TD5M or TD5F Continued

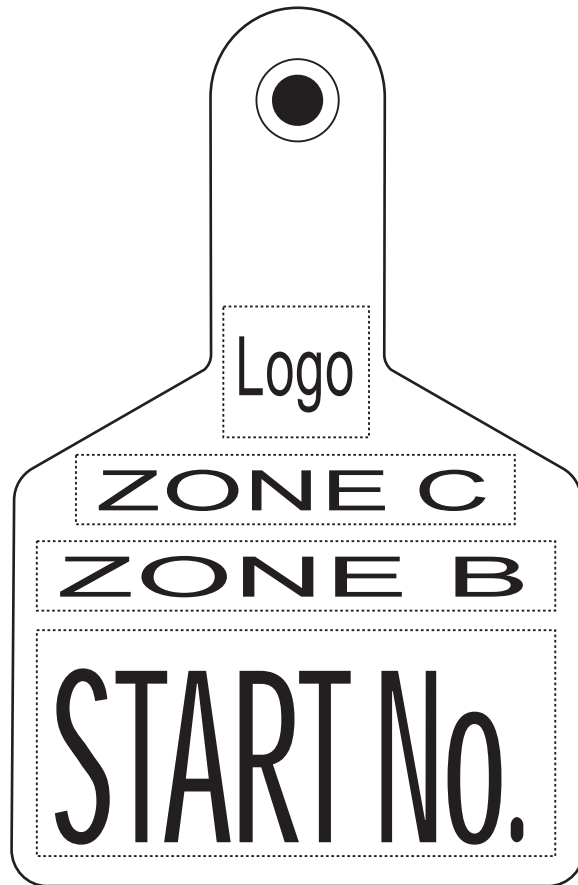

TPRT4
Print Option 4

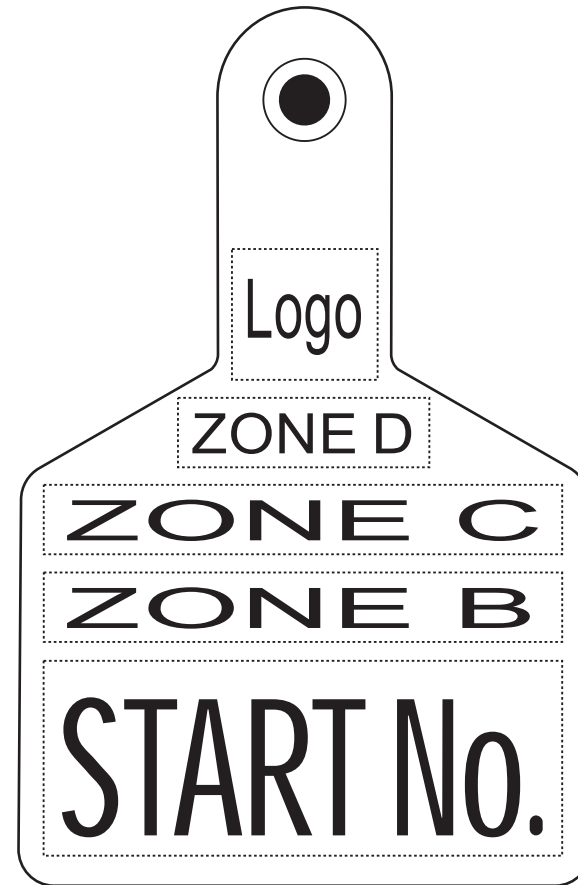

TPRT5
Print Option 5

Supertag Large (Size 4) TD4M or TD4F



TPRT1
Print Option 1



TPRT2
Print Option 2



TPRT3
Print Option 3



TPRT4
Print Option 4

Supertag Medium (Size 3) TD3M or TD3F



TPRT1
Print Option 1



TPRT2
Print Option 2



TPRT3
Print Option 3

Supertag Pig (Size 2) TSD2M or TD2F



TPRT1
Print Option 1



TPRT2
Print Option 2



TPRT3
Print Option 3

Supertag Small (Size 1) TD1M or TD1F



TPRT1
Print Option 1



TPRT2
Print Option 2



TPRT3
Print Option 3

Supertag Button (Size 0) TD0M or TD0F

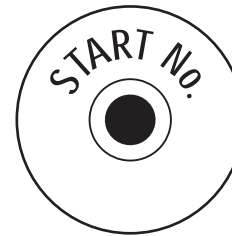

TPRT1
Print Option 1

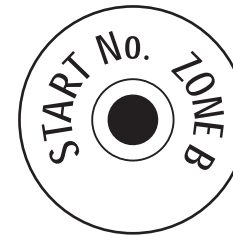

TPRT2
Print Option 2



TPRT3
Print Option 3

Rototag TDL0

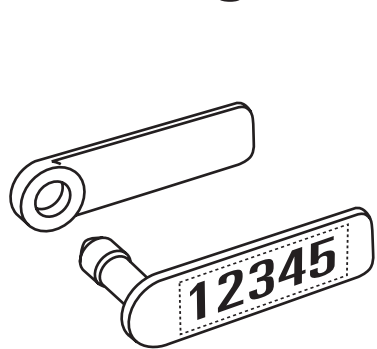

TPRT1
Print Option 1

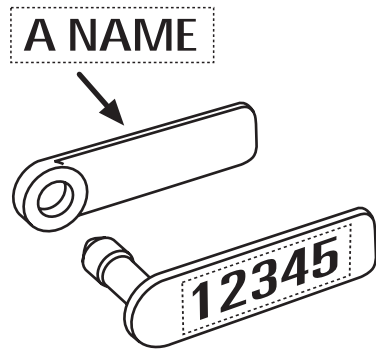

TPRT2
Print Option 2

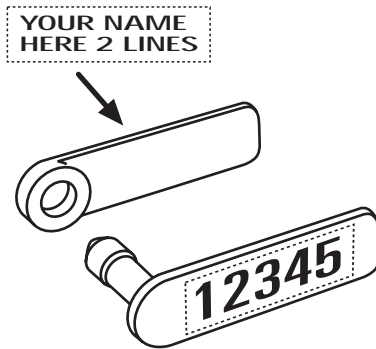

TPRT3
Print Option 3

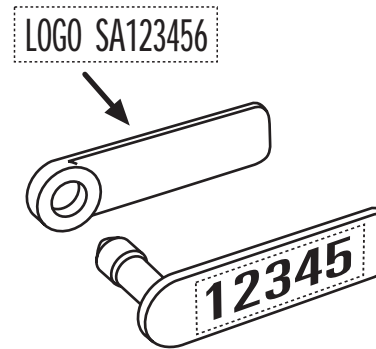

TPRT4
Print Option 4
(NLIS)

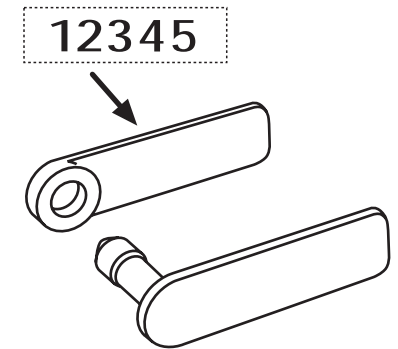

TPRT5
Print Option 5

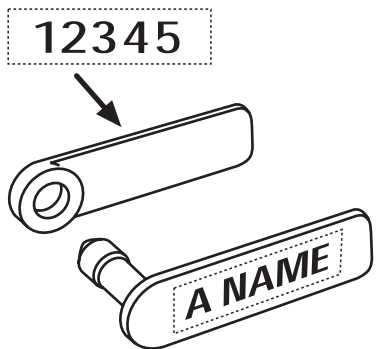

TPRT6
Print Option 6

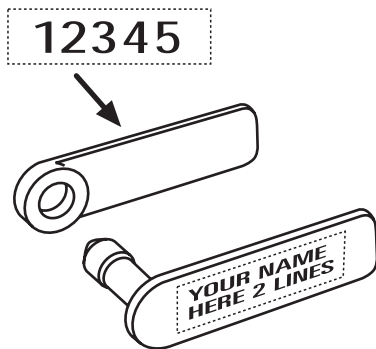

TPRT7
Print Option 7

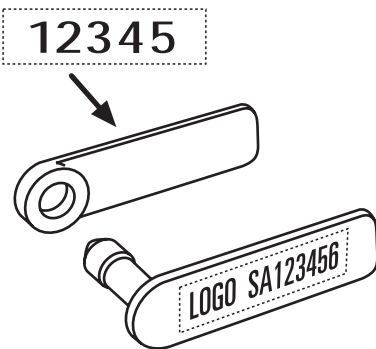

TPRT8
Print Option 8
(NLIS)

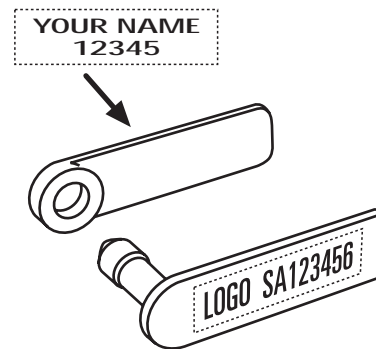

TPRT9
Print Option 9
(NLIS)

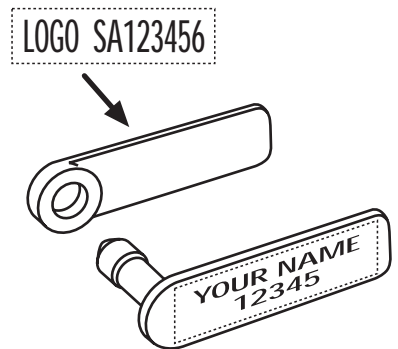

TPRT0
Print Option 0
(NLIS)

Tagomatic TDL0

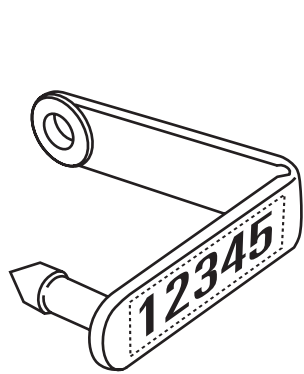

TPRT1
Print Option 1

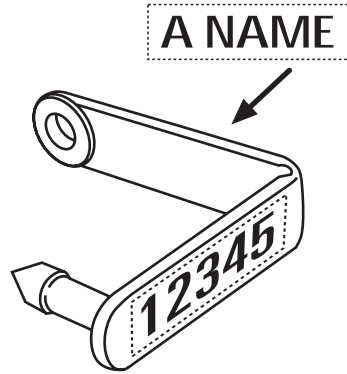

TPRT2
Print Option 2

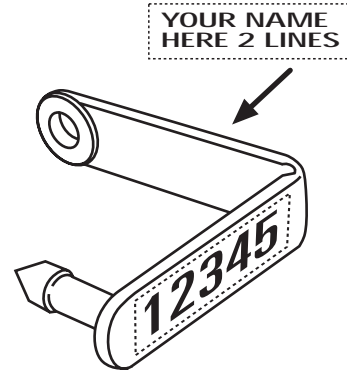

TPRT3
Print Option 3

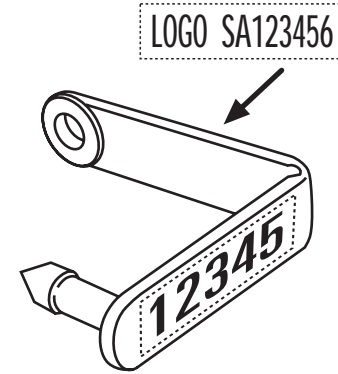

TPRT4
Print Option 4
(NLIS)

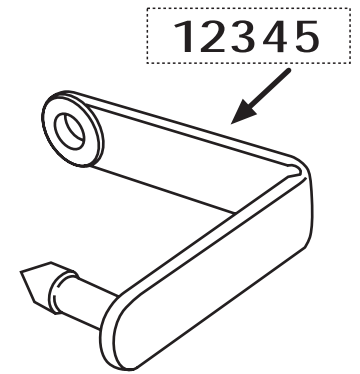

TPRT5
Print Option 5

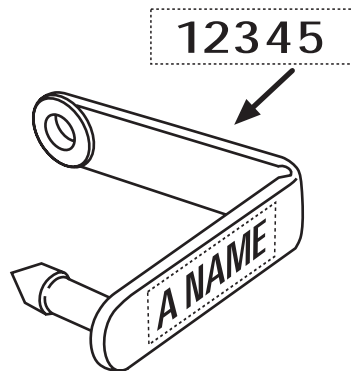

TPRT6
Print Option 6

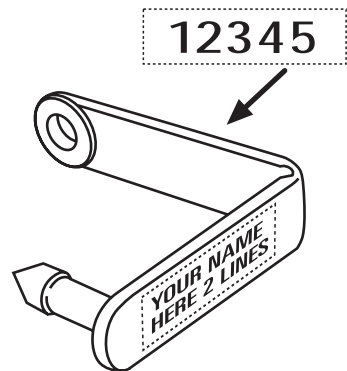

TPRT7
Print Option 7

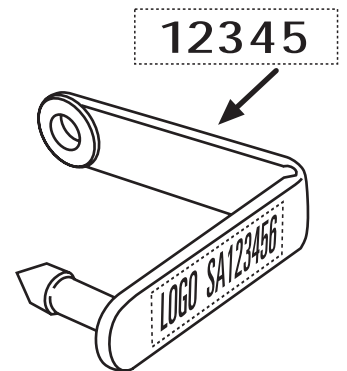

TPRT8
Print Option 8
(NLIS)

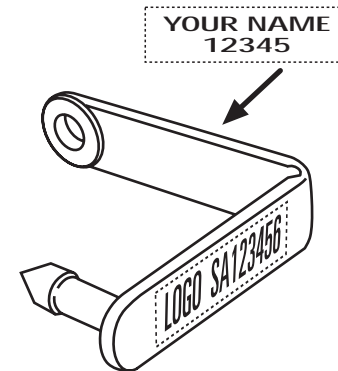

TPRT9
Print Option 9
(NLIS)

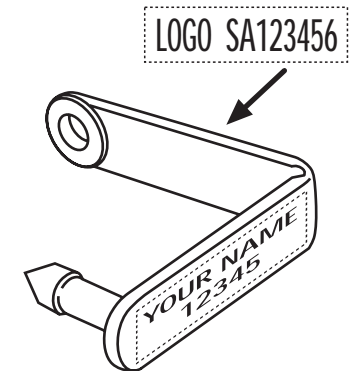

TPRT0
Print Option 0
(NLIS)

Supertag Size 1 Small TD1MF

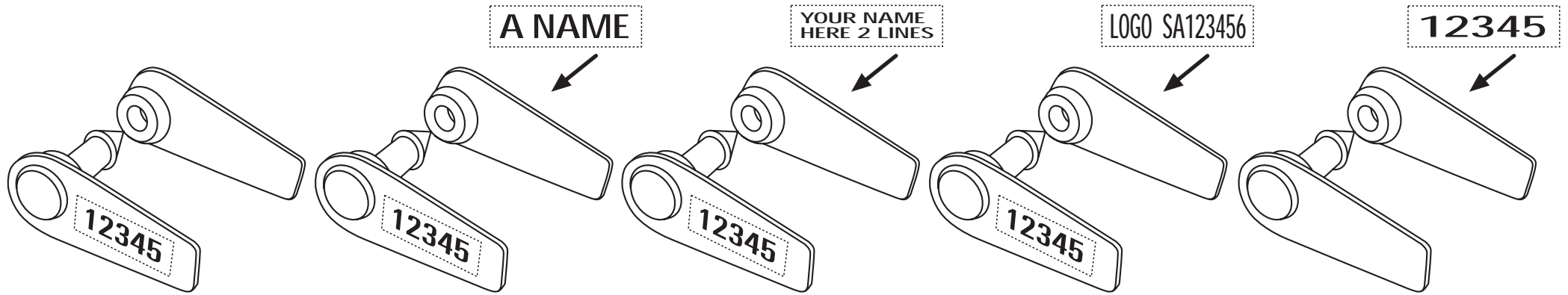

TPRT1
Print Option 1

TPRT2
Print Option 2

TPRT3
Print Option 3

TPRT4
Print Option 4
(NLIS)

TPRT5
Print Option 5

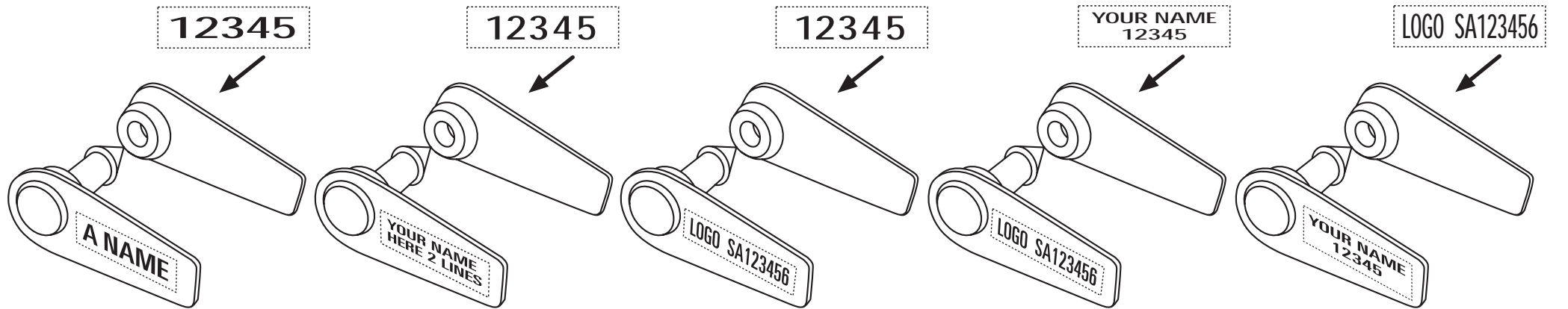

TPRT6
Print Option 6

TPRT7
Print Option 7

TPRT8
Print Option 8
(NLIS)

TPRT9
Print Option 9
(NLIS)

TPRT0
Print Option 0
(NLIS)

I-Tag male for Sheep & Lambs TSDM

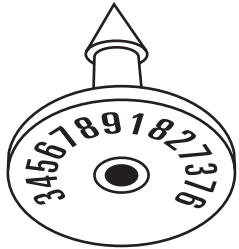

TPRT1
Print Option 1



TPRT2
Print Option 2



TPRT3
Print Option 3
(NLIS)

I-Tag for Sheep TS1F

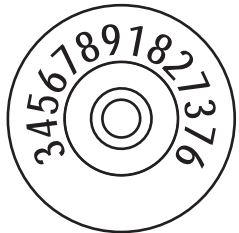

TPRT1
Print Option 1



TPRT2
Print Option 2



TPRT3
Print Option 3
(NLIS)

I-Tag for Lambs TSSF

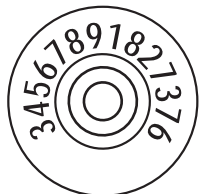

TPRT1
Print Option 1



TPRT2
Print Option 2



TPRT3
Print Option 3
(NLIS)

Supertag NLIS Cattle (HDX) TDT6MF

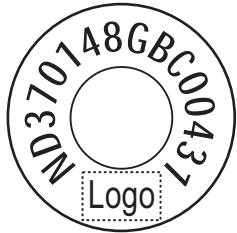

TPRT3
Print Option 3
Female Side



TPRT3 (NLIS)
Print Option 3
Male Side

I-Tag for Cattle & Merino Sheep (FDX) TSDF

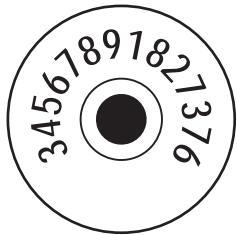

TPRT1
Print Option 1



TPRT2
Print Option 2

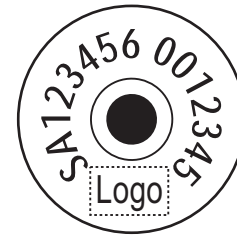

TPRT3
Print Option 3